



Android / iOS

Smart Security Alarm System User Manual



Product Introduction

The smart security alarm kit is based on the intelligent security host, which is paired with PIR detector, door magnetic sensor, and wireless remote controller to build an intelligent security system. It not only can reach anti-theft alarming, but also be linked with smart sockets and devices to get to smart life.

Main Functions

- Connect to WiFi, App control
- Wireless communication, no need wiring
- Freely switchable national standard / European plug
- The alarm is not triggered, and the indicator light shows the effect of breathing light
- 50pcs detectors can be added, each detector can be programmed
- Low power-consumption design
- Accessories low power notification
- Intelligent scene recognition, unclosed reminder
- Volume is adjustable

- Built-in doorbell DingDong, with 17 bands of eight chord music to switch
- Built-in alarm tone is optional, with 32 bands of eight chord music to switch
- Defense zones support Disarm, Arm, Home Arm, 24H Arm, Delay Arm, etc for option
- Built-in back-up battery, have notification when power off or incoming call

Schematic Diagram of Smart Alarm Gateway:

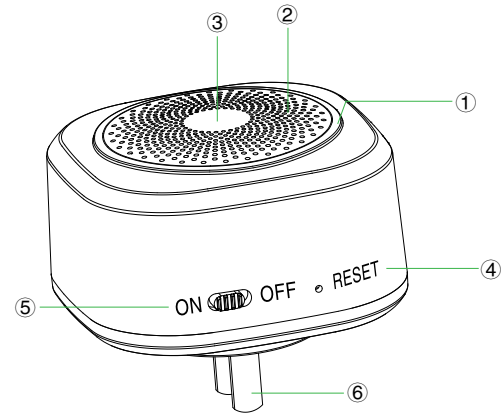

① The indicator light has various status indications, as follows:

- ※ Flashing once every 1 second indicates automatic network distribution
- ※ Flashing once every 5 seconds indicates manual network distribution
- ※ If the indicator light is always on, it means that the arming is successful.
- ※ If the indicator light is off every 2 seconds, it means that the arm is home arm.
- ※ The breathing light is displayed every 6 seconds
- ※ The alarm indicator light flashes quickly

② Speaker: play doorbell ringtone / alarm ringtone

③ SOS button

④ Reset: Long press Reset for 5s for network configuration automatically; If failed, continue to press Reset for 5s for network configuration by hand; Short press Reset for coding accessories

⑤ Battery power switch: battery-powered switch

⑥ Power plug interface

Fast Setting

Step 1: App download

- In App store or Google Play, search “TuyaSmart” and download; or Scan the below QR code.
- After downloading the App, please register and login according to the interface.
- After open the App, click <Register>, use your mobile phone number or e-mail address to register.



Android / iOS

Step 2: Alarm Panel Wi-Fi Connection

- ① Make sure your mobile phone already connected by Wi-Fi (Only support 2.4GHz Wi-Fi network)
- ② Open “TuyaSmart” App, Click “+” on the top right corner; Choose others → Gateway (Wi-Fi)
- ③ Gateway gets into network connection status: Firstly switch on the gateway, long press [Reset] for 5s, release the key after hearing 1 beep sound, gateway will start network configuration automatically
- ④ Click “Confirm” in the App, and choose Wi-Fi, input Wi-Fi code, click “Confirm” to connect Wi-Fi; When Wi-Fi indicator is always on, means network connection OK.

P. S:

The gateway should be very near to the router to make sure network configuration easily and fast.

Don't support 5G Wi-Fi network at the moment

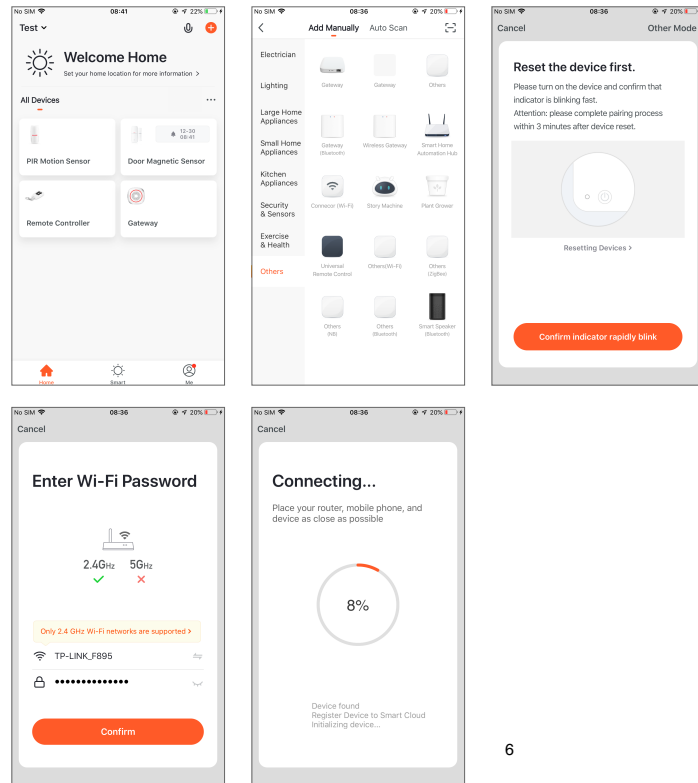

Step 3: Detectors coding

If you buy our smart gateway, the sensors and remote controllers already coded into the gateway, then no need to add again.

If you want to add new sensors or new devices which are factory restored, please choose the methods below for adding.

Method 1 (App): Open “TuyaSmart” App, in the Smart alarm Gateway (Wi-Fi) → Accessory → Fast adding → when you hear a beep sound from gateway after trigger sensors indicates receive device signals, it means coding successfully. Sensors can be door magnetic sensor, PIR sensor, remote controller, siren, smart socket, and wireless keypad, etc. (Method 1 and 3 are recommended)

Method 2(App): Open “TuyaSmart” App, in the Smart Gateway (Wi-Fi) → Accessory → Add Sub-device → when you hear a beep sound from gateway after trigger sensors indicates receive device signals, it means coding successfully. Sensors can be Door magnetic sensor, PIR sensor, Remote controller, Siren, Smart socket, and wireless keypad, etc. (Method 1 and 3 are recommended)

Method 3 Device pairing (smart gateway): Short press RESET, alarm gateway has a BEEP sound,.When you hear a beep sound from gateway after trigger sensors indicates receive device signals, it means coding successfully. Sensors can be door magnetic sensor, PIR sensor, Remote controller, Siren, Smart socket and wireless keypad, etc.

Adding PIR sensor, switch it ON, when you a hear beep sound from gateway means coding successfully. PIR needs 1 minute to warm up.

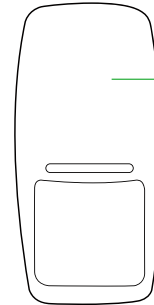

ON Power
Switch ON

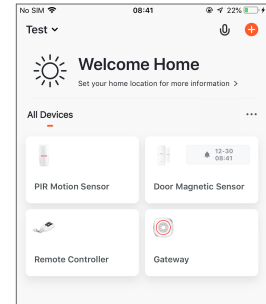

Adding door detector: install battery or pull magnet, indicator light of door detector is always on, when you hear a beep sound from gateway means coding successfully.

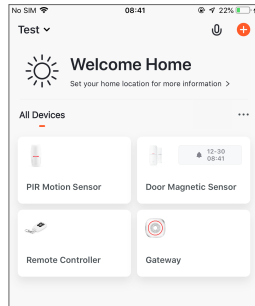
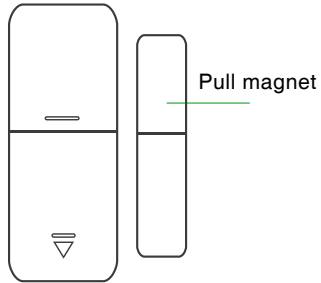

Adding remote controller: press any button on the remote controller, when you hear a beep sound gateway means coding successfully.

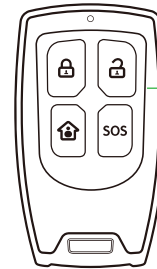

Press any button
on the remote
controller

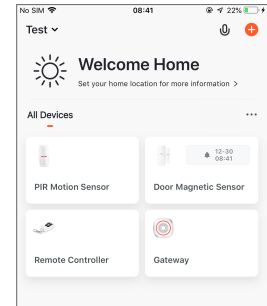

APP Operation:

Detectors setting:

Function Settings of remote controller: click remote controller to set on main interface.

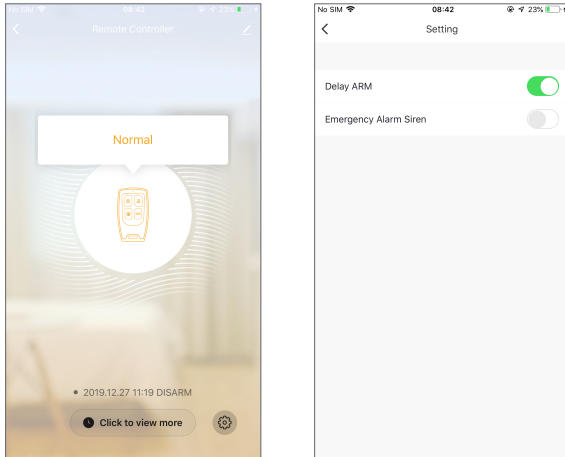

Function settings of door detector: click door detector to set on main interface

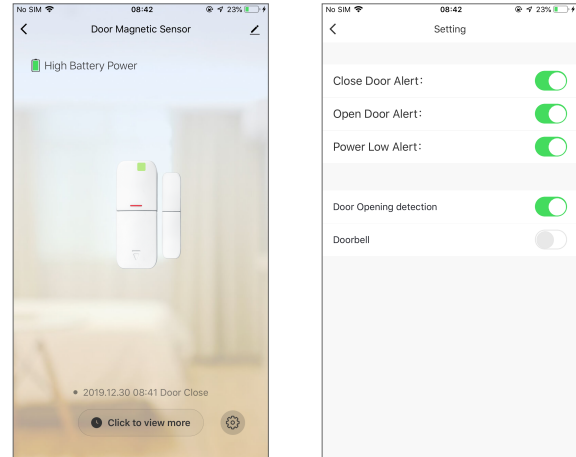

Function setting of PIR detector: click PIR detector to set on main interface

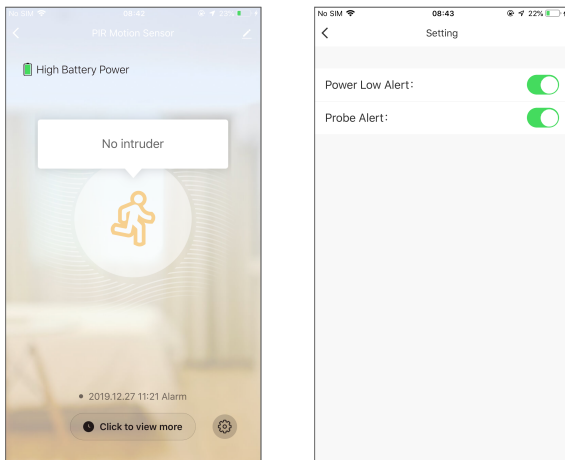

Adding external wireless siren: go into alarm gateway→setting→wireless control→switch turns green, it means turn on transmit wireless pairing. Siren is status of pairing (please read user manual of siren when siren pairing), press any button on the remote controller, gateway transmit wireless signal means coding successfully.

Defence Zones Program Setting: all detectors was paired, System Armed as default, 24 hours valid for remote controller.

Bypass: Click the switch on the right side of the detector to be gray, indicating that the detector is bypassed, and the switch to green to indicate that the detector is enabled.

Valid for 24 hours: first click the effective arming area, pop-up drop-down, select 24-hour effective, click OK, the detector will move to within 24 hours.

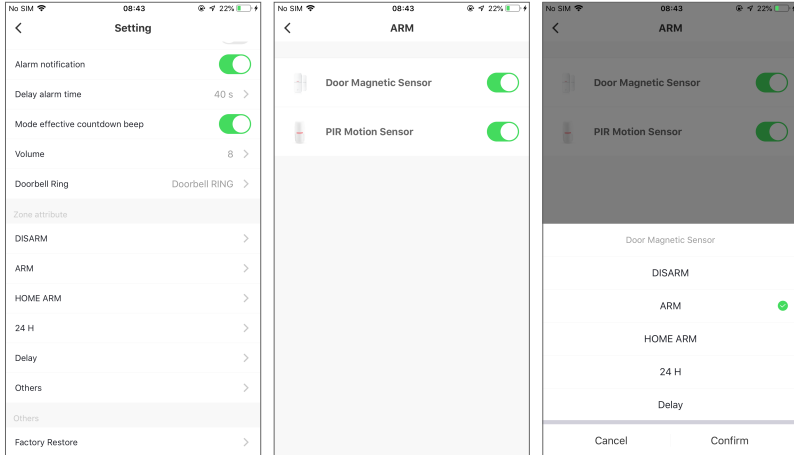

Defence zone type	Disarm	Away alarm	Home alarm
Disarm valid	Alarm	No alarm	No alarm
Arm valid	No alarm	Alarm	No alarm
Home arm valid	No alarm	No alarm	Alarm
24 Hours Defense zone	Alarm	Alarm	Alarm
Delay Defence Zone	Alarm	Alarm	No alarm
Other	No alarm	Alarm	Alarm

Daily Operation

4.1 Arm

When System Armed, alarm panel “ARM” indicator is Normally ON, and with voice notification: System Armed. Any intruders will trigger alarm. Ways below can Arm the system:



4.2 Disarm:

When System Armed, alarm panel “ARM” indicator is Normally OFF, and with voice notification: System Disarmed. Ways below can Disarm the system:



4.3 Home Arm

When System is in Home Arm Status, The “ARM” indicator will be always ON with voice notification: System Home Armed. Open the valid detectors at this status, if any intruders to detect, system will alarm.

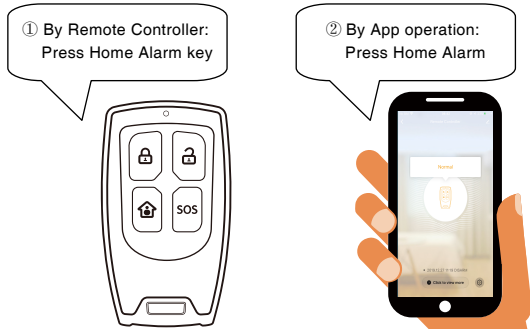

4.4 SOS Emergency Calling

In Emergent situation, press SOS key on the remote controller to trigger alarming. Way below to start SOS alarm:



Factory Restore

Open TuyaSmart App, click gateway to enter setting page. Click “Factory Reset”, and a beep Dong, means factory reset is OK. All devices will disappear from the App.

Installation

Smart alarm gateway installation diagram:

Please attention, do not place the alarm gateway and router too far, it is suitable for 2 to 5 meters.

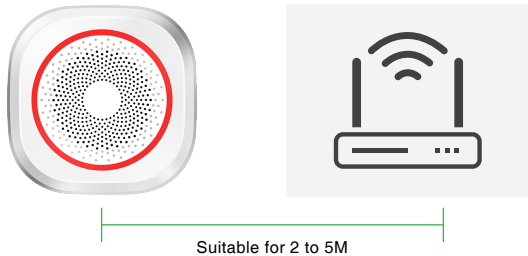

Door detector installation diagram:

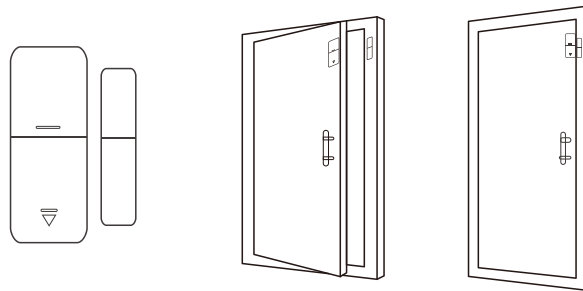

Please attention:

1. Magnetron distance is less than 10mm to install
2. After installed, open the door to test, door sensor indicator is ON proves installation OK;The door sensor emits a signal when it is opened
3. When open/close door, App push low-voltage notification, replace battery as soon as possible to make sure door sensor working normally
4. Transmitting distance is less than 100m without obstacles, and please test after installed; Different obstacles will have different transmitting distance;
5. Push the cover up to open, and replace the battery

PIR detector installation diagram:

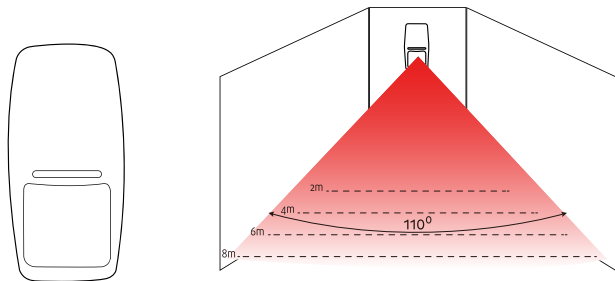

To reduce the false alarm, something to be attention when we install the PIR sensor:

- ① Away from the straight sunshine
- ② Do not face the big object which is easy to swing
- ③ Do not face the cold and heat air vent or cold and heat source
- ④ The furniture, miniascape, or any other isolations should be away from the detecting scope

- ⑤ Do not install 2 or more detectors in the same area or it will cause the interference when alarm
- ⑥ When open/close door, App report low-voltage, replace battery as soon as possible to make sure door sensor working normally
- ⑦ Detecting distance is no more than 8m , and transmitting distance is no more than 150m without obstacles. Please test after installed. Different obstacles will have different distance.

Products parameters:

Smart Alarm Gateway

Input Voltage: AC 85V-250V

Built-in lithium battery: 250mah 3.7V

Battery StandbyTime: 4 hours

WIFI Standard: IEEE 802.11 b/g/n

Wireless Receiving frequency: 433M \pm 75KHZ 330K EV1527

Wireless transmitting frequency: 315M \pm 75KHZ 330K EV1527

Wireless distance: \leq 80M (in open space)

Working Temperature: -10°C - +50°C

Humidity: \leq 90%RH

Size: 70*70*40mm

Remote controller

Input voltage: 3V CR2032

Standby current: $\leq 10\mu\text{A}$

Alarm current: $\leq 15\text{mA}$

Wireless frequency: 433M $\pm 75\text{KHZ}$ 330K EV1527

Wireless distance: $\leq 80\text{M}$ (in open space)

Working temperature: $-10^{\circ}\text{C} \sim +50^{\circ}\text{C}$

Humidity: $< 80\% \text{ RH}$

Door detector

Input voltage: 12V 23A

Standby current: $\leq 10\mu\text{A}$

Alarm current: $\leq 45\text{mA}$

Wireless frequency: 433M $\pm 75\text{KHZ}$ 330K EV1527

Wireless distance: $\leq 80\text{M}$ (in open space)

Working temperature: $-10^{\circ}\text{C} \sim +50^{\circ}\text{C}$

Humidity: $< 80\% \text{ RH}$

PIR detector

Input voltage: 9V 6F22

Standby current: $\leq 35\mu\text{A}$

Alarm current: $\leq 45\text{mA}$

Wireless frequency: 433M $\pm 75\text{KHZ}$ 330K EV1527

Wireless distance: $\leq 80\text{M}$ (in open space)

Detection distance: 8M/110°

Working temperature: $-10^{\circ}\text{C} \sim +50^{\circ}\text{C}$

Humidity: $< 80\% \text{ RH}$

Maintenance:

System checking

Although alarm system is used everyday, please must keep maintenance and check in regular to assure that it can run stably, reliably and safely. Usually thorough test must be performed on the gateway every three months. You'd better check the detector once every month.

Check gateway

- ① Whether it can arm/disarm normally on App.
- ② Whether it can properly push the message to the APP
- ③ Whether it can receive wireless detectors' signal normally
- ④ Whether the back-up battery can work normally.

Check the wireless detectors:

- ① Trigger wireless detectors to see if system can alarm normally.
- ② Check all detectors' batteries to see if it's in low voltage.
- ③ Check whether wireless detectors can send signal to the main unit normally.

Notes:

- ① Please do not disassemble, repair and alter the products without permission, or it may cause accidents and faults.
- ② Do not drop this product on the ground or on hard objects, as it may lead to massive impact to cause faults and damages.

Common Fault

Fault	How to Solve
Gateway can't connect to Wi-Fi	<ul style="list-style-type: none"> ● Make sure if it is too far for the gateway and the router
	<ul style="list-style-type: none"> ● Make sure the router is 2.4GHz
	<ul style="list-style-type: none"> ● Make sure if the local IPS has limitation to the quantity of devices to connect to Wi-Fi
Gateway setting can't be set on App	<ul style="list-style-type: none"> ● Make sure if the network is good or not
App has no notification to receive	<ul style="list-style-type: none"> ● Make sure if remove the App; Or App authority open or not
The host can't receive the alarm signals from accessories	<ul style="list-style-type: none"> ● Make sure accessories paired to the host successfully ● Make sure the accessories OK

Alarm still in real-time after set Delay Arm	<ul style="list-style-type: none">• Make sure if programmed the defense zones delay
No SMS notification when the host Power Off	<ul style="list-style-type: none">• Make sure if have set alarm telephone number when the host power off
Siren not working	<ul style="list-style-type: none">• Make sure if connect to AC power• Make sure if set close the siren when alarming
Accessories distance is too near	<ul style="list-style-type: none">• The battery of the accessory is insufficient• The power of the gateway is insufficient? Is it plugged in?• Is there interference?