

1 Statement

Thank you purchasing our products, if you have any questions or needs, please contact us.

This manual applies to wireless network video recorder.

2 Attentions

- Please check when unpacking boxes, confirm the items and lists.
- Please don't make the kit fall to ground or be hit by strong forces.
- Please keep good ventilation environment around this product.
- Avoid installation in severe vibration environments.
- Please avoid environment with much humidity, dust, extreme heat or extreme cold of the power supply carefully.
- Please avoid environment with much humidity, dust, extreme heat or extreme cold of the power supply carefully.
- Please keep the product box to facilitate transfer or removal of the equipment.
- Please make sure to turn off power of all items during installation. Check the voltage properly.
- Please contact the distributor or service center if the kit is damaged or not working.

3 Open-package inspection

After receive product, please open gift box then check accessories. If any damage or lack, kindly please contact to the distributor.

Packing list

S/N	Item	QTY
1	NVR Host	1
2	Screw bag(4 screws for HDD)	4
3	USB Mouse	1
4	DC 12V@2A Power supply	1
5	Product user manuals	1
6	Wireless IP Camera	4/8
7	DC 12V@1A Power supply	4/8
8	Screw bag(4 screws for HDD)	4/8

4 Product description

4.1 Wireless Camera

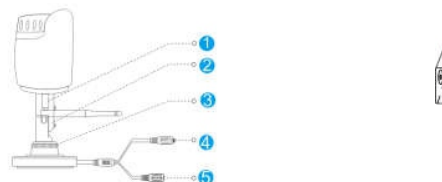

S/N	Item	Description
1	Antenna interface	Install antenna
2	Setscrew	Fixed bracket
3	Knob	Adjust the camera angle
4	Reset	Pair button
5	Power Supply	12VDC power supply.

4.2 Wireless NVR

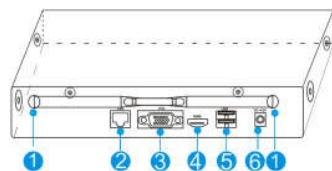

S/N	Item	Description
1	Antenna	Install antenna
2	Reset	Pair button
3	VGA	DB9 connector for VGA output
4	HDMI	HDMI video output connector
5	USB	USB ports for additional devices such as USB mouse, U disk
6	Power	12VDC power supply.

5 Installation of device

Note: 1. A factory recommended HDD should be installed

befor power on.

2. The maximum of hard disk capacity is 4TB.

5.1 Install HDD to NVR

(1) Unfastening the screws on the rear panel, and side panel. and Remove the cover from the NVR.

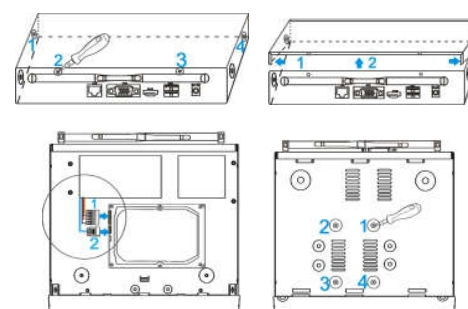

(2) Connect the data cable and power cable to HDD.

(3) Fasten the screws on the bottom to fix the HDD.

(4) Re-install the cover of the NVR and fasten screws.

5.2 Cable Connection

Connect the wire as below diagram

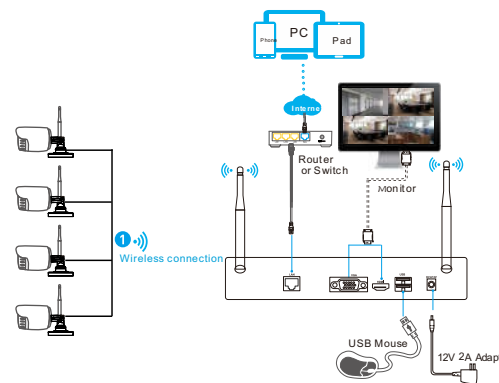

Notes:

In order to guarantee the video quality, IPC antenna should try to keep in parallel or tangent with NVR antenna.

Because the signal of surrounding antenna is much stronger, but much weaker if antenna endpoints back off direction.

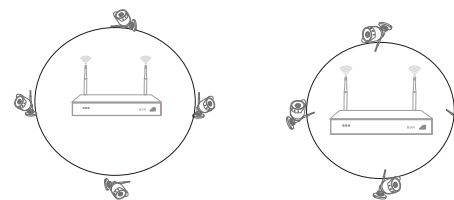

Correct method

Fault method

6 Local Operation

6.1: Power on

Check the power supply is plugged into an electrical outlet, and turn on the button. Then the power LED should red, and the video will automatic display on the monitor, after several minutes.



6.2: Login

(1) Click right mouse button, log-in menu pops up.
 (2) Enter the correct password, default password is admin.

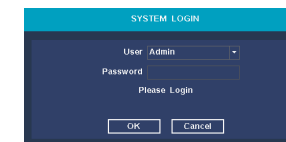

Note: Please modify the user password before using the product to protect your privacy.

Password modification: Main menu → The system menu → Account → Modify Pwd

6.3: Format the hard disk

(1) Right click to login and enter "Main menu→System →HDD manager".
 (2) Then click "Format Disk" button.
 (3) The hard disk status would turn on "in use".



6.4: Network configuration

(1) Conform network cable is connected to LAN correctly for access the internet.

- Enter into "Main menu→System→Network Config" menu.
- Select "DHCP", and click "save" button, it'll request IP address from the DHCP server automatically.
- The configuration is **Successful**, if the IP address is not 0.0.0.0. After refresh. Otherwise, please set the IP address and gateway information Manually.

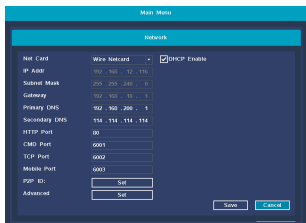

7 Mobile Phone view

Step 1: Install software

Scanning the QR code in the user manual to download, and install it.

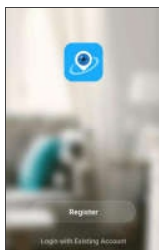

- Download QR code
- Startup

Step 2: Tap "Register" button to register Account.

Step 3: Add device

After login, Tap "+" button in the main interface view to open the device adding view.

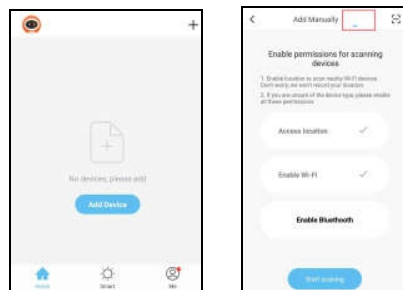

- add device window
- tap autosearch

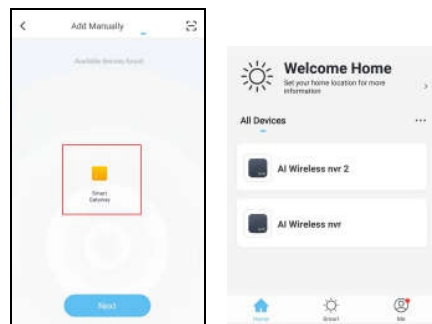

- select device
- device list

Step 3: Live view

Tap the online device icon in the device list, the channel's video will be connected and display automatically.

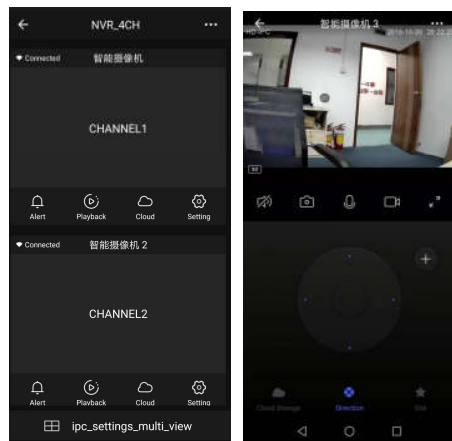

- Channel list
- Live view

Icon	description	Icon	description
	Device info and share		Multi-screen
	Alarm info list		Snap
	Playback on device		Talk
	Cloud Record		SD/HD
	Channel Setting		

8 Other operation

8.1 Video playback

Steps: Right click to select playback → login → select single or multi channel playback mode → select channel → select date → double click to start play record.

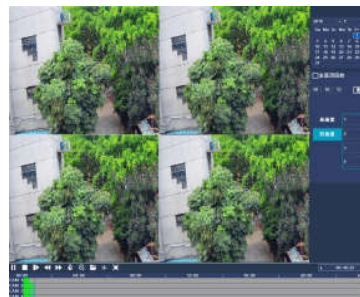

8.2 Video backup

Steps: Insert U disk to USB interface → Right click to select Main menu → login → select backup → select channel → set starting time and ending time → click "Search" button → select the record → select or create new file → click "Backup" button to backup record.



8.3 Add camera

Add or replace wireless camera, please follow the steps below.

- Wait 1 minutes for camera start up.
- Enter "Main menu→Pair IPC" window, →delete not connected camera → Click "Pair" button, pop-up a textbox → Push the pair button in IPC within 5 seconds. pair successfully when display "connected" in status column.
- Repeat step b, then click [OK] button to finish.

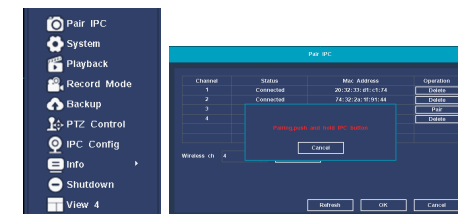

Hiseepro download QR code

